

BMC
SWITZERLAND 



Max torque
4 bolt stem: 6 Nm
2 bolt stem: 8 Nm

SHIMANO

Roadmachine

Integrated Cockpit
Assembly

Roadmachine

Integrated Cockpit (IC)

Instruction Manual

The new Roadmachine 01 represents the pinnacle of functional integration. By patiently following the guidelines below, the assembly process will lead to properly fitting and functioning equipment with a high-performance, Swiss Engineered aesthetic.

Contents

1.	General Assembly Notes and Warnings	3
2.	Tools and Materials	3
3.	Stem Parts	4
4.	Frame Fit	5
4.1	Determining Handlebar Position	6
5.	Frame Assembly	7
5.1	Brake Mounting	7
5.2	Cable Routing	7/8
5.3	Preparing and Installing Fork	9/10
5.4	Installing headset and ICS01 Stem	11
5.5	Finishing assembly	11

1. General Assembly Notes and Warnings

Due to the high level of integration of the Roadmachine 01 Integrated Cockpit, proper assembly requires a high degree of mechanical skill and specialized tools. It is critical that the assembly and maintenance is performed by a qualified professional.

In order to successfully assemble the Roadmachine 01 and the Integrated Cockpit it is important to follow the order of operations outlined in this guide. Failure to follow the outlined procedure can result in an assembly process that is more difficult than necessary and an end product that performs less than ideal.

WARNING: The Roadmachine 01 Integrated Cockpit (fork, stem, headset and stack spacers) are all proprietary components that cannot be substituted with non-specified components. Substitution of any of these components can compromise the integrity of the entire system and should under no circumstances be substituted. Failure to follow this warning can result in serious injury or death.

2. Tools and materials

Allen keys: 3, 4, 5mm

Open-end wrench: 7, 8mm

Brand-specific hydraulic tools

High quality grease

Carbon paste

Torque wrench

Steerer tube cutting guide

Carbon fiber cutting blade

PF-86 BB Installation tool

3. Stem Parts

Integrated Cockpit Stem (ICS01)

ICS01 Stem (90/100/110/120/130)	1
Stem Faceplate	2
Cable guide	3
Stack spacers	4
IC Fork inserts	5
Cable cover	6
Cable clamp	7
Di2 Junction A mount (optional)	8

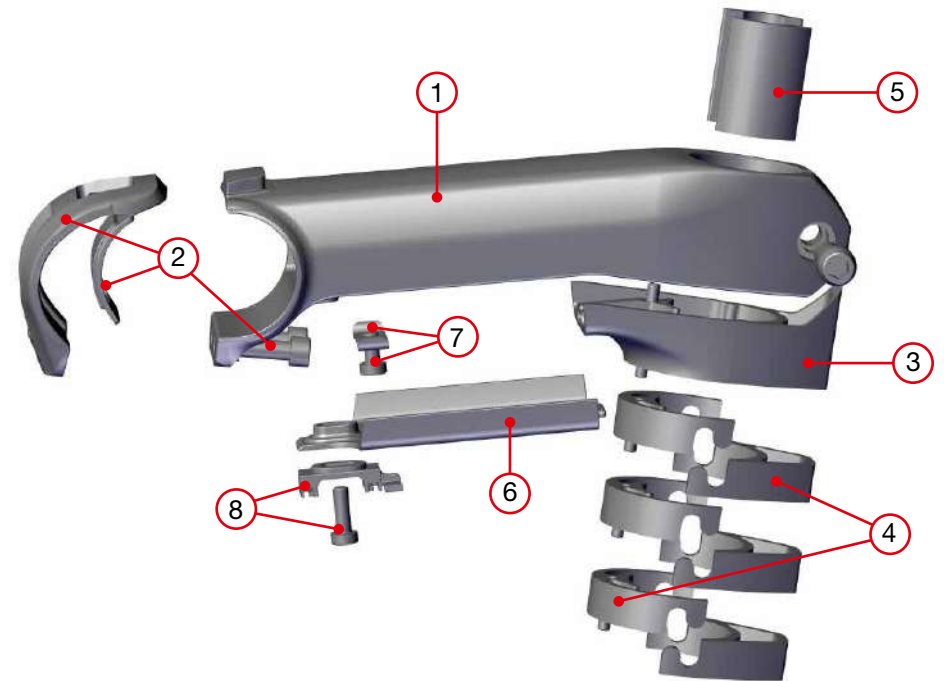

4. Frame Fit

The unique integration of the Roadmachine 01 & 02 and the Integrated Cockpit with 'Dual-Stack' options requires a slightly modified measurement of traditional frame stack and reach. The stack and reach for Roadmachine 01 & 02 rely on the center-top measurement of the 'Dual-Stack' headset top cap spacer, as seen below. The Roadmachine 03 follows a traditional measurement system of center-top of head tube.

'Dual-Stack' measurement system



Roadmachine 03 – Traditional

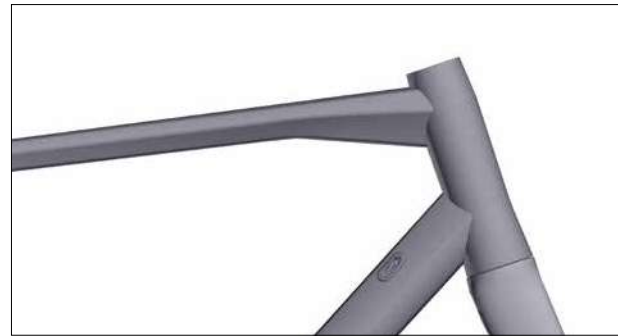

4. Frame fit

4.1 Determining handlebar stack and reach

It is strongly recommended that riders either use their existing bike measurements or work with a qualified bike fit expert to establish a proper handlebar stack and reach position prior to assembly.

For existing bikes, the online fit tool can be used to replicate the existing measurement on to the new Roadmachine 01/02:

<https://b2b.bmc-switzerland.com/en-us/tools/roadmachine-sizing>

Stack = HB1-BB1 = _____ mm (550 - 715)

Reach = HB2-BB2 = _____ mm (440 - 530)

Seat height = _____ mm (609 - 895)

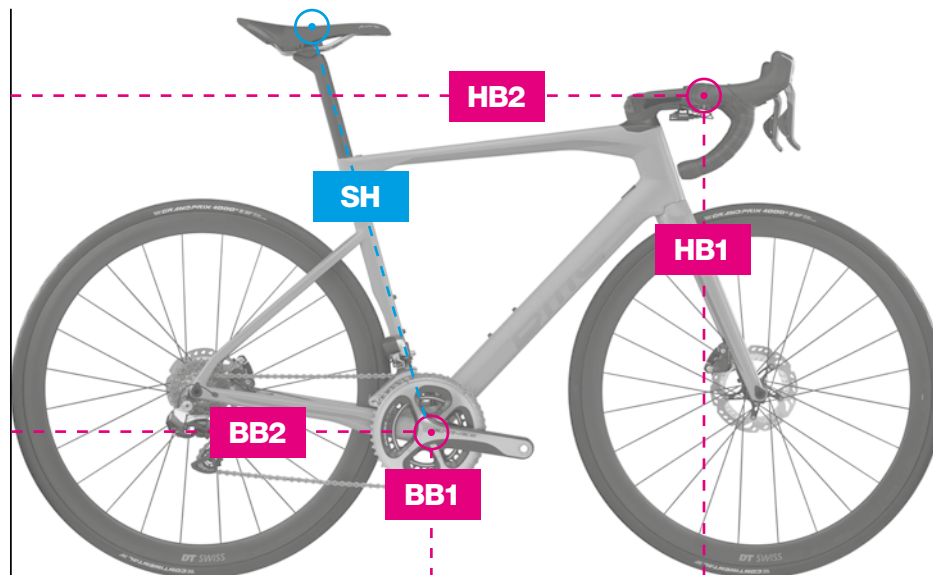

Handlebar measurement

Vertical: center of bar

Horizontal: center of bar

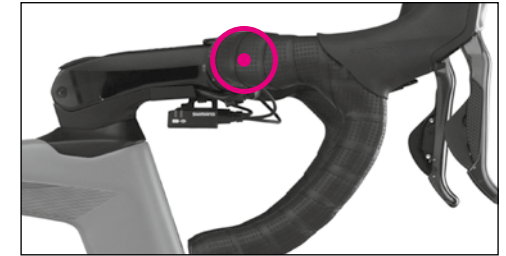

BB measurement

Vertical: center

Horizontal: center



Seat height measurement

Vertical: top of saddle

Horizontal: fore/aft mid-point



5. Frameset assembly

5.1 Brake Mounting

The new Roadmachine 01/02 proprietary front brake mounting hardware comes with the ability to accommodate 140/160mm rotors. Qualified service providers can position the adapter to create seamless integration and optimal function for either rotor size.

Front brake

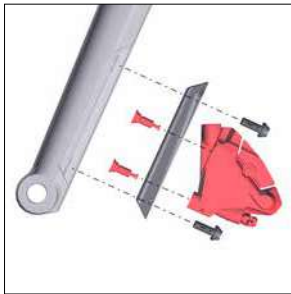

140 mm

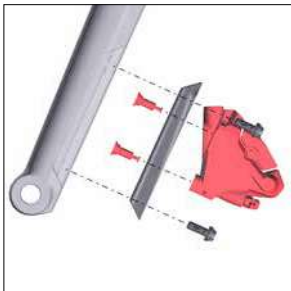

160 mm

Rear brake



140 mm



160 mm

Note: Roadmachine 03 will utilize Shimano flatmount hardware front and rear – reference the Shimano service guide for proper assembly

5.2 Cable Routing

5.2.1 Brakes

Start the housing routing at the caliper and pass to the front

The rear brake hydraulic housing will pass UNDER the bottom bracket



Install the provided foam sleeve on the rear brake housing in the downtube



It is recommended to assemble the caliper-end hydraulic system (connector insert, olive, and inserting the threaded connector bolt) – this will help hold the hose in place during future assembly steps

5. Frameset assembly

5.2 Cable Routing

5.2.2 Drivetrain

DTi frame fittings vary between frame platform (01/02) and drivetrain options (mechanical / electronic).

- Install proper DTi frame fittings for your frame and drivetrain

In the case of electronic systems, we strongly recommend assembling the system and checking all connections before routing cables through the frame.

Roadmachine 01 electronic



Downtube covers

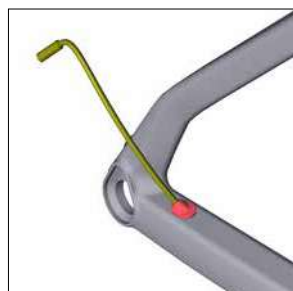

Rear derailleur cable exit



BB cover

Roadmachine 02 electronic



Rear brake and Di2 cable



Rear derailleur cable exit



BB cover

Roadmachine 01 mechanical

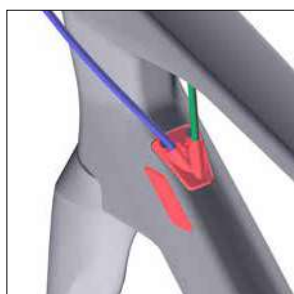

Drivetrain housing exit



Rear derailleur cable stop



BB cable guide

Roadmachine 02 mechanical

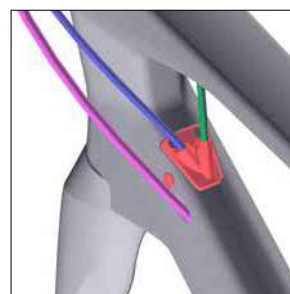

Drivetrain & brake housing exit



Rear derailleur cable stop



BB cable guide

5. Frameset assembly

5.3 Preparing and Installing Fork

5.3.1 Measuring fork length

- Install the headset components, cable guide, stem, and steerer inserts.

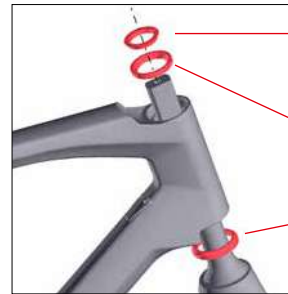

- Install steerer compression ring
- Install upper bearing
- Install lower bearing & fork

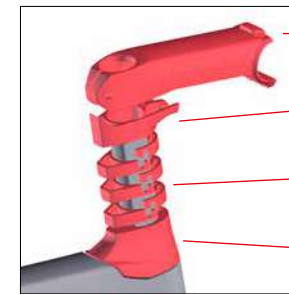

- Install stem
- Install stem cable guide
- Install stack spacers
- Install headset top cap

- Gently compress the system together and tighten the stem steerer tube clamp bolt gently.

△ **Warning:** without IC Fork steerer inserts, tightening the stem steerer clamp bolt can compromise the integrity of the steerer tube – leading to serious injury.

Verify the handlebar position!!



Install steerer spacers before tightening stem clamp!

- Using a felt-tipped marker, make a mark on the steerer tube at the top of the stem.
- After verifying handlebar position, and marking stem height, uninstall the fork and headset from the frame.

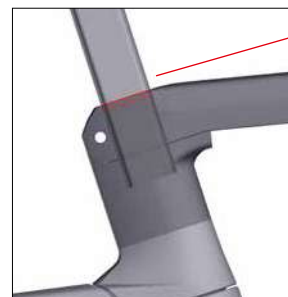

- Mark steerer at top of stem

5. Frameset assembly

5.3 Preparing and Installing Fork

5.3.2 Cut fork

- Use the mark on the steerer tube to assign a proper cutting location.

**Cut the steerer tube
3mm below the mark!**

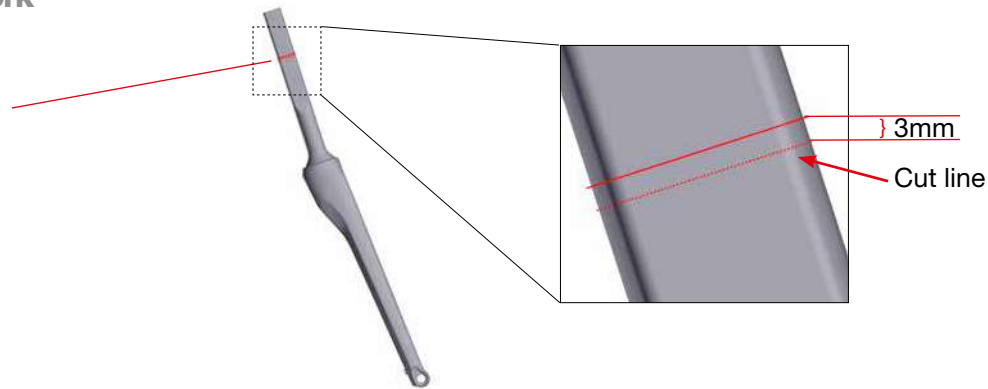

5.3.3 Install self-tapping compression nut

- The Roadmachine 01 IC Fork comes with an internal channel which receives a self-tapping compression nut.
- Install the self-tapping compression nut, making certain it remains aligned with the steerer
- Tighten until the top of the compression nut is flush with the top of the fork

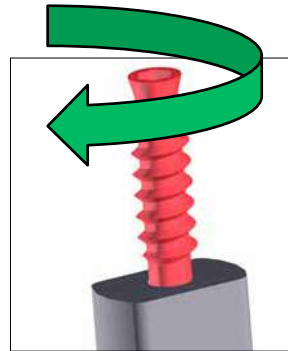

5.3.4 Route brake housing

- Route the housing through the internal guide, starting at the axle dropout and working towards the steerer tube.
- It is recommended to assemble the caliper-end of the hydraulic system (connector insert, olive, and inserting the threaded connector bolt) – this will help hold the hose in place during future assembly steps.

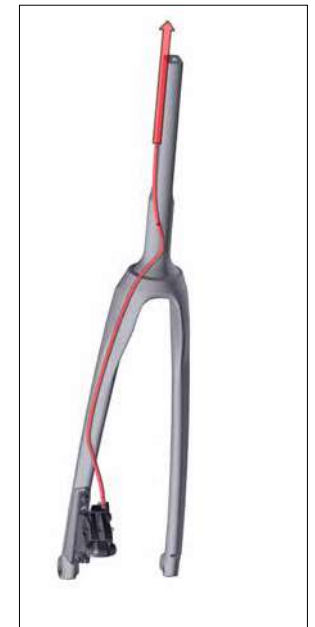

5. Frameset assembly

5.4 Installing headset and ICS01 Stem

- Install the fork and headset, using grease on all contact surfaces
- Arrange and align cable routing - brake lines can be positioned in the opposite position (Left – Rear, Right – Front)
- Install headset top cone (high or low stack) and spacers
- Install stem cable guide and gently position cables downward
- Install ICS Stem and steerer tube inserts
- Install top cap and compression bolt
△ **3Nm max torque**
- Install stem steerer clamp bolt - grease required
△ **7Nm max torque**
- Install stem cable clamp
- Install stem cable cover
- Install optional Junction A mounting unit

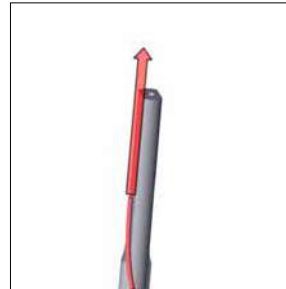

Route the front brake housing to the non-drive side



Install bearings and compression ring – cables will sit securely on flat sides of steerer tube

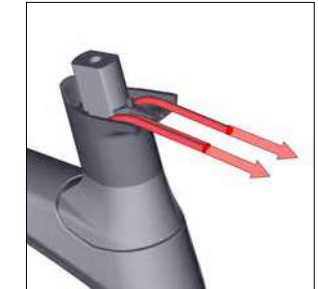

Install top cone, spacers and cable guide – gently fold cable downward



Install stem and steerer inserts



Install top cap



Install stem steerer clamp bolt - grease required!

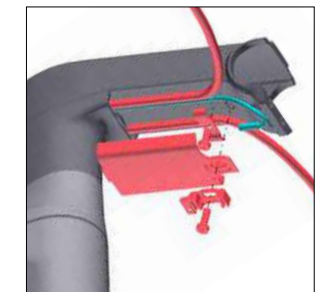

Install cable clamp and cable cover & Di2 junction box mount (optional)



Install faceplate and faceplate cover – make sure the top faceplate ‘puzzle’ clamp is securely engaged



Install Di2 junction box (optional)

5.5 Finishing Assembly

- Assemble and adjust brake and drivetrain equipment per manufacturer’s instructions